

Remote Access for Allen-Bradley PLC(s)

Rockwell Automation – SLC500 Series or Logix Series

APPLICATION NOTE

AUG-0035-00 2.3 en-US ENGLISH

Important User Information

Disclaimer

The information in this document is for informational purposes only. Please inform HMS Industrial Networks of any inaccuracies or omissions found in this document. HMS Industrial Networks disclaims any responsibility or liability for any errors that may appear in this document.

HMS Industrial Networks reserves the right to modify its products in line with its policy of continuous product development. The information in this document shall therefore not be construed as a commitment on the part of HMS Industrial Networks and is subject to change without notice. HMS Industrial Networks makes no commitment to update or keep current the information in this document.

The data, examples and illustrations found in this document are included for illustrative purposes and are only intended to help improve understanding of the functionality and handling of the product. In view of the wide range of possible applications of the product, and because of the many variables and requirements associated with any particular implementation, HMS Industrial Networks cannot assume responsibility or liability for actual use based on the data, examples or illustrations included in this document nor for any damages incurred during installation of the product. Those responsible for the use of the product must acquire sufficient knowledge in order to ensure that the product is used correctly in their specific application and that the application meets all performance and safety requirements including any applicable laws, regulations, codes and standards. Further, HMS Industrial Networks will under no circumstances assume liability or responsibility for any problems that may arise as a result from the use of undocumented features or functional side effects found outside the documented scope of the product. The effects caused by any direct or indirect use of such aspects of the product are undefined and may include e.g. compatibility issues and stability issues.

Table of Contents

Page

1	Preface	3
1.1	About This Document	3
1.2	Document history	3
1.3	Related Documents	3
1.4	Trademark Information	3
2	Requirements	4
2.1	Hardware	4
2.2	Software.....	4
3	Objective.....	5
4	Prepare your Ewon for Remote Access.....	6
5	Configure your Ewon for Remote Access.....	7
5.1	Step 1: Create your Ewon in Talk2M	7
5.2	Step 2: Prepare the Configuration File	9
5.3	Step 3: Apply the Configuration File	10
5.4	Step 4: Connect to your Ewon Remotely	11
5.5	Step 6: Terminate the Remote Connection	13
6	Link an Ewon to the PLC	15
6.1	Serial Port Configuration	15
6.2	Ethernet Port Configuration	17
7	PLC Software Mapping.....	18
8	PLC Remote Access.....	21
9	Troubleshooting	23
9.1	Cannot Reach Serial PLC?	23
9.2	Cannot Reach Ethernet PLC ?	23
9.3	Check the Configuration of an Ewon Flexy	23

A	Configure your Ewon for Remote Access using the Web Interface.....	25
A.1	Step 1: Set the LAN IP Address of your Ewon	25
A.2	Step 2: Configure the Ewon Internet Connection	28
A.3	Step 3: Create Your Ewon in Talk2M.....	31
A.4	Step 4: Retrieve the Talk2M Activation Key.....	31
A.5	Step 5: Connect Your Ewon to Talk2M	33
A.6	Step 6: Connect to Your Ewon Remotely	34
A.7	Step 7: Terminate the Remote Connection	35
B	Ewon as the PLC Gateway	36
B.1	SLC500 Series	36
B.2	Logix Series	37
C	Security Aspects	39
C.1	Login security	39
D	Types of Serial DF1 Cables	41
D.1	Serial Cable 1747-CP3	41

1 Preface

1.1 About This Document

This document explains in a few steps how to configure your Ewon device, your Talk2M account and the PLC software to access the Allen-Bradley for remote diagnosis and programming.

For additional related documentation and file downloads, please visit www.ewon.biz/support.

1.2 Document history

Version	Date	Description
1.0	2010-10-24	First release
2.0	2011-04-22	Major update – reformulation, new document organization
2.1	2011-06-01	Automated IP config recognition (eCatcher/Talk2M part)
2.2	2011-06-23	Plug'nRoute impact - changed 6.3 partly moved to Appendix 2, 9.3 moved to Appendix 2. Cosmetic corrections.
2.3	2019-03-01	Added: Talk2M Easy Setup Changed: New layout

1.3 Related Documents

Document	Author	Document ID
Ewon Configuration for Internet Access Using the Wizard	HMS	AUG-0019-00
Easy Commissioning via SD Card and USD Drive	HMS	AUG-0062-00
PLC Discovery through Talk2M	HMS	AUG-0070-00
WAN Connection Fallback	HMS	KB-0286-00

1.4 Trademark Information

Ewon® is a registered trademark of HMS Industrial Networks SA. All other trademarks mentioned in this document are the property of their respective holders.

2 Requirements

2.1 Hardware

To complete this guide, you need the following items:

- an Ewon with VPN capabilities,
- Allen-Bradley PLC,
- a computer to configure the Ewon and the Allen-Bradley PLC.

2.2 Software

2.2.1 Ewon Related

The following pieces of software are needed to configure your Ewon:

- a modern web browser (min. version: Firefox 15, Chrome 16, Safari 6 and Edge 13),
- [eBuddy](#): Ewon configuration and maintenance utility.
- [eCatcher](#): Talk2M remote access utility. Version 6.4 or higher.

2.2.2 Allen-Bradley Related

- **RSLinx** communication utility,
- **RSLogix500** if you intend to connect to a PLC of the SLC500 series,
- **RSLogix5000** if you intend to connect to a PLC of the Logix series.

3 Objective

The objective of this document is to guide you through the steps required to enable remote access of the Allen-Bradley.

The remote access setup is composed of 4 different parts:

- communication with the Ewon through the Internet,
- connection of your Ewon to the Allen-Bradley PLC,
- configuration of the PLC software so it can communicate through the Ewon,
- access to your PLC through the Internet.

If you connect to an Ewon for the first time, we recommend reading the “Quick Start Guide” document shipped with your Ewon.

4 Prepare your Ewon for Remote Access

The LAN IP address of your Ewon and of your PLC must be in the same IP range.

If you choose the Ethernet or Wi-Fi WAN interface to connect to the Internet, the Ewon requires a LAN IP address on the machine side and a WAN IP address on the network (remote site) side.

Before configuring your Ewon LAN IP address and by consequence, the IP address of your PLC, ask to your network administrators what is the specified company LAN network range used as WAN connection by the Ewon to connect to the Internet.

The LAN ports of your Ewon and thus the PLCs plugged in the Ewon must be in a range outside the ones used by the *Site LAN*.

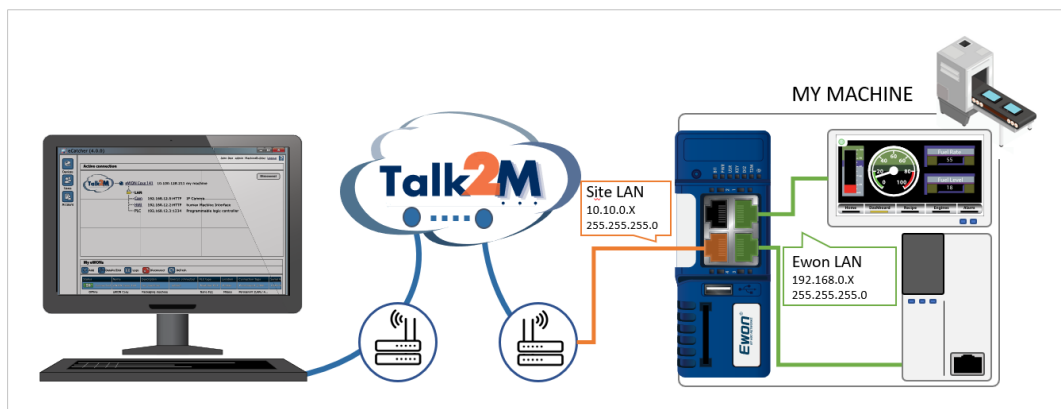

Fig. 1 IP ranges involved in an Ethernet / Wi-Fi network.

In the above example, we could select IP addresses in the **192.168.0.#** range for the Ewon LAN and PLCs since it does not overlap with the *Site LAN* range.

If you choose the cellular WAN interface to connect to the Internet, the Ewon requires only a LAN IP address compatible with the PLC IP address.

5 Configure your Ewon for Remote Access

This section explains how to configure the remote access of your Ewon through Talk2M service.

Before going through the configuration of your Ewon to set the remote access, we recommend reading the [Prepare your Ewon for Remote Access, p. 6](#).

5.1 Step 1: Create your Ewon in Talk2M

The first step consists in listing your Ewon inside your Talk2M account using the [eCatcher](#) software.



If you already created your Ewon in your Talk2M account, through eCatcher, you can skip this step and go to the next step.

To create your Ewon in Talk2M, apply the following procedure:

1. Connect your computer to the Internet.
2. Verify that you have an Internet connection.

For example: open your web browser and browse to your favorite web page.

3. Open eCatcher and log in to your Talk2M account.

If you don't have any Talk2M account, please follow the video tutorial "Create a Talk2M Account" available on the [Ewon elearning platform](#).

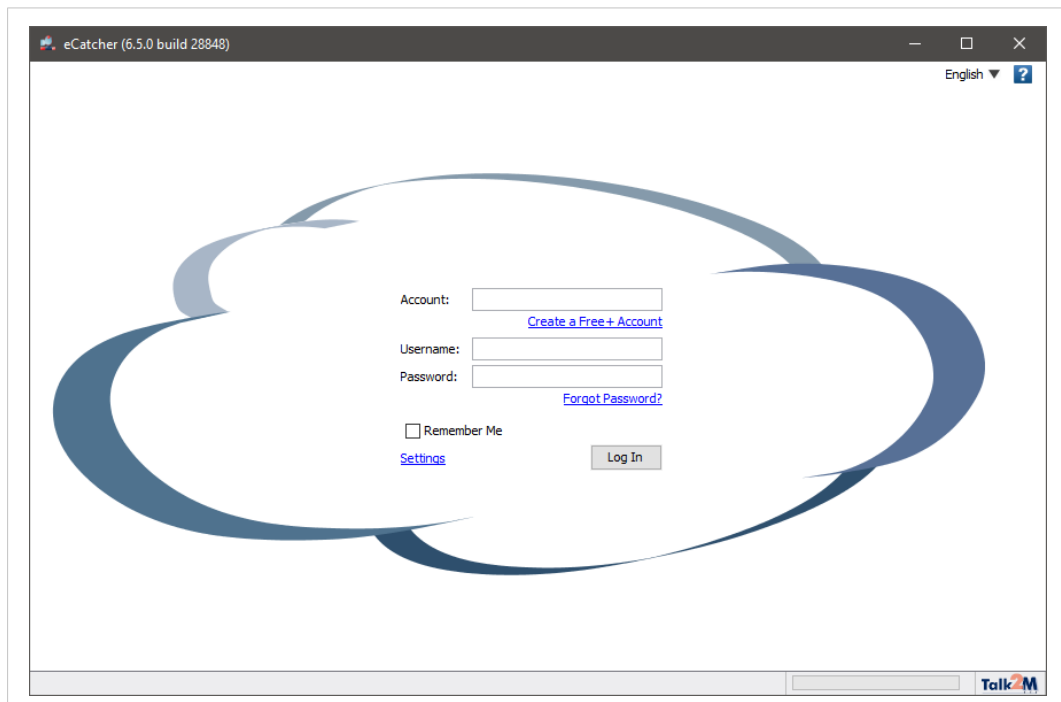

Fig. 2 Add an Ewon in eCatcher — 1

- On eCatcher's main interface, click the **+ Add** icon. A new window appears.

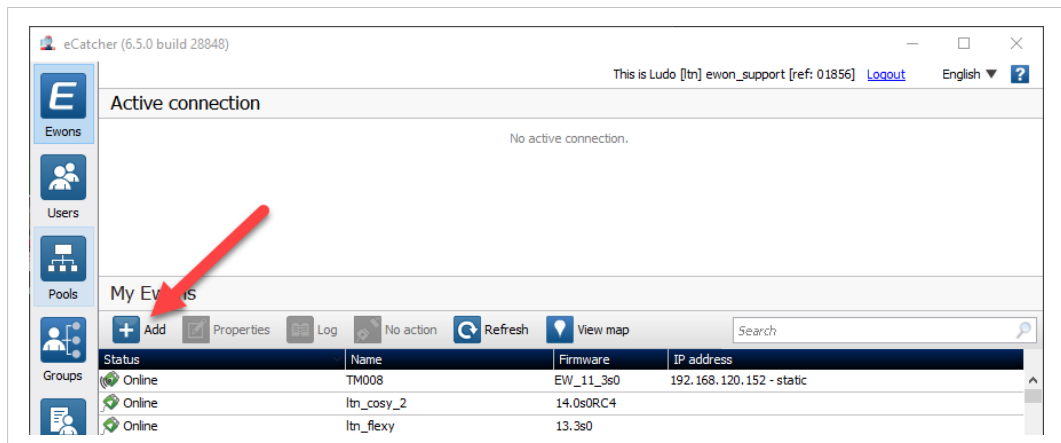

Fig. 3 Add an Ewon in eCatcher — 2

- Enter the name of your Ewon.

The Talk2M server displays this name to identify the remote connection to your Ewon

- Select the **Connection Type** to specify how your Ewon connects to the Talk2M server. You can choose between two possibilities:

- Permanent: for Ethernet, Wi-Fi or cellular models. Your Ewon stays permanently online.
- Triggered: only for cellular models. Your Ewon is offline (but still functional) until you wake it up with an SMS.

If you specify a triggered connection, then eCatcher asks for the phone number of your Ewon. The phone number allows Talk2M to send an SMS which wakes up your Ewon.

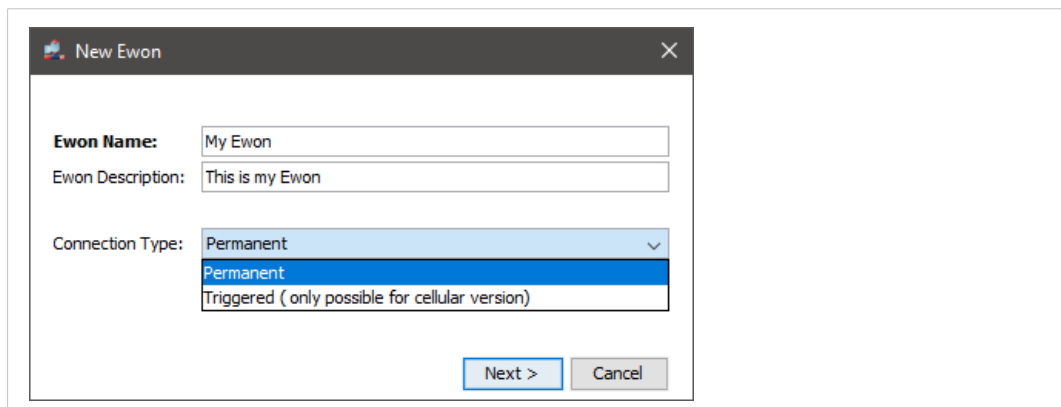

Fig. 4 Add an Ewon in eCatcher — 3

- Click **Next**.

- Enter custom information concerning your remote connection. You can use the **Custom Fields** to classify or filter your different remote connections (your different Ewons).

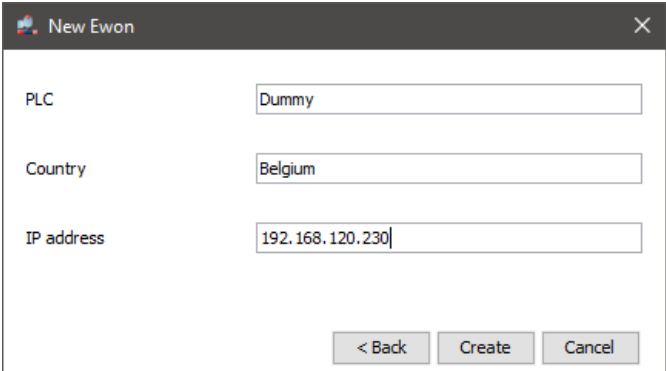

Fig. 5 Add an Ewon in eCatcher — 4

- Click **Create**.

The newly created Ewon is now linked to your Talk2M account.



If you have a Talk2M Pro account, you need to add the Ewon to a pool/group of Ewons before being able to create the new Ewon entry.

eCatcher displays the “Talk2M Connectivity” frame. Follow the [Step 2: Prepare the Configuration File, p. 9](#) to continue the configuration of the remote access.

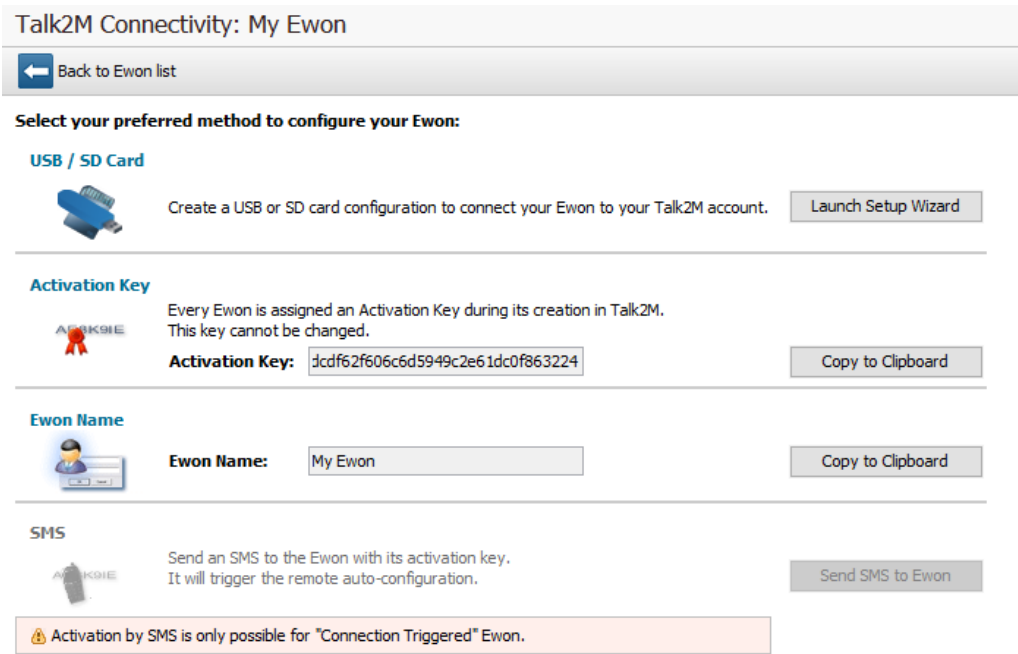

Fig. 6 Talk2m Connectivity in eCatcher

5.2 Step 2: Prepare the Configuration File

To access remotely your Ewon, you need to configure the Internet and the Talk2M VPN connection of your Ewon.

The configuration explained in this section uses the *Talk2M Easy Setup* feature embedded in the eCatcher (as of v6.4). If you wish to configure your Ewon through eBuddy and Ewon web interface, please refer to [Configure your Ewon for Remote Access using the Web Interface, p. 25](#) from the Appendix.

eCatcher offers the possibility to create a commissioning file which includes all the configuration parameters useful to configure such connections.

eCatcher stores the commissioning file on an SD card or a USB flash drive. You can then insert the SD card or USB flash drive in your Ewon which automatically applies the configuration parameters available on the SD card / USB flash drive.



To apply the following configuration, your Ewon must run (minimum) Ewon firmware version 13.2s0 for the USB drive and 11.0s0 for the SD card.



If you decide to use a USB flash drive combined with a Ewon Flexy, you need the Flexy USB extension card: FLB 3601.

Once eCatcher displays the “Talk2M Connectivity” frame, apply the following procedure:

1. Insert an SD card or USB flash drive in your computer. Make sure the card or the key is of FAT32 format.
2. Click the **Launch Setup Wizard** button of the **USB / SD Card** first row.
3. Select the WAN interface of your Ewon.
4. Depending on the interface you choose, different configuration fields are required:
 - Ethernet: WAN IP settings.
 - Wi-Fi: SSID settings.
 - Cellular: SIM card and APN settings.

For Ethernet and Wi-Fi, make sure to complete the advanced settings if necessary.

5. Click **Next**.
6. Set the LAN IP address of your Ewon. Check [Prepare your Ewon for Remote Access, p. 6](#) for more information.
7. Click **Next**.
8. Select the location where eCatcher should export the file.
9. Click **Save** twice to confirm the export.

The last screen is an explanation how to proceed with the SD card / USB flash drive and your Ewon. You can also follow [Step 3: Apply the Configuration File, p. 10](#).

5.3 Step 3: Apply the Configuration File



The following configuration works only if your Ewon hasn't been registered on Talk2M (or is not currently linked to a Talk2M account).

To configure your Ewon for remote access, apply the following procedure:

1. Make sure your Ewon is powered on.

2. Insert the SD card or the USB flash drive in your Ewon.

The Ewon detects the insertion in a very short period (5 seconds maximum) and you can visualize this detection by the quick orange blinking pattern of the USR LED (ON / OFF each 150 msec).

3. Wait for the Ewon to process the configuration files.

After the detection of your SD card or USB flash drive, comes the process of what inside. You can visualize the process of the files by the slow orange blinking pattern of the USR LED (ON / OFF each second).

4. Check the status of the USR LED.

After the process of the configuration files, your Ewon shows if it was able to apply the configuration. The result is as follows:

- solid green: success
- solid red: failure

5. Remove the SD card or the USB flash drive. The removal induces the reboot of the Ewon.

6. Within 2 minutes after the reboot, your Ewon should be online in eCatcher.

You can find a complete explanation on the Ewon easy commissioning with the “Easy Commissioning via SD Card and USD Drive” document from [Related Documents, p. 3](#).

5.4 Step 4: Connect to your Ewon Remotely

Now that the Ewon is connected to Talk2M, you can establish the remote connection to this Ewon.

Depending on the type of connection you set, the procedure changes.

5.4.1 Permanent Connection

To connect remotely to an Ewon tagged as permanent connection, follow the procedure:

1. Connect your computer to the Internet.
2. Verify that you have an Internet connection.

For example: open your web browser and browse to your favorite web page.

3. Open eCatcher (if not already opened).
4. Select the Ewon you just configured in the “My Ewons” list.

- Click the green **Connect** button displayed in the Ewon list menu to establish the remote connection. eCatcher is now attempting to establish a VPN connection to the Talk2M server.

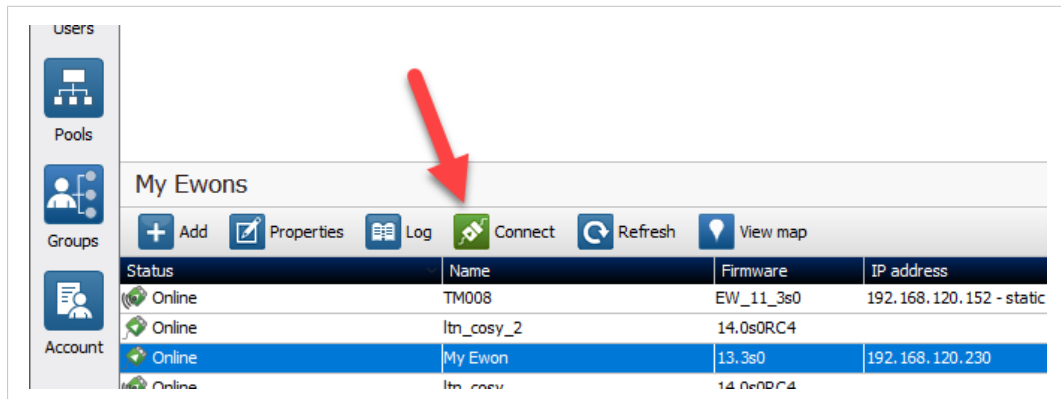

Fig. 7 Connection to an Ewon

- Once the VPN connection established, eCatcher displays the Ewon in the “Active connection” section.

The computer is now connected to the Ewon using the VPN tunnel and you can use the remote connection.

You can click the **IP address** link in the “Active Connection” section to display, in a web browser, the homepage of the Ewon web interface.

5.4.2 Triggered Connection

To connect remotely to an Ewon tagged as triggered connection, follow the procedure:

- Connect your computer to the Internet.
- Verify that you have an Internet connection.
For example: open your web browser and browse to your favorite web page.
- Open eCatcher (if not already opened).
- Select the Ewon you just configured in the “My Ewons” list.

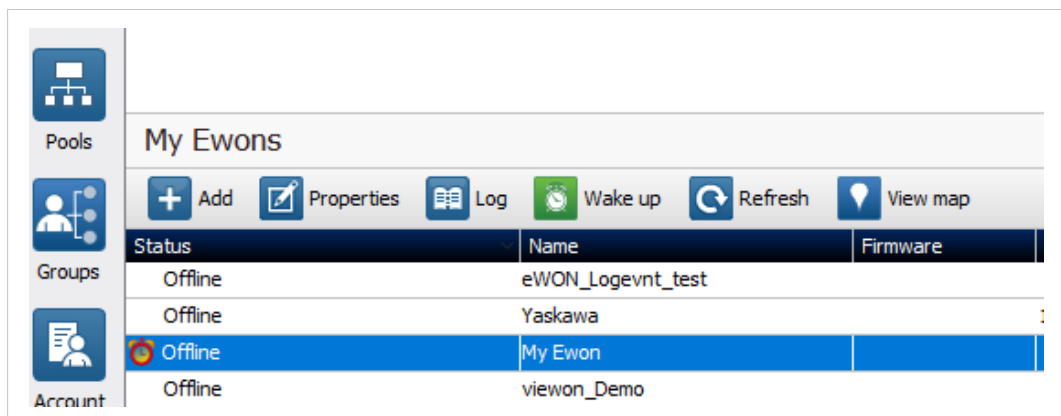

Fig. 8 Wake up your Ewon — 1

- Click the green **Wake up** button displayed in the Ewon list menu to wake up your Ewon. By doing so, eCatcher sends an SMS to switch your Ewon online.

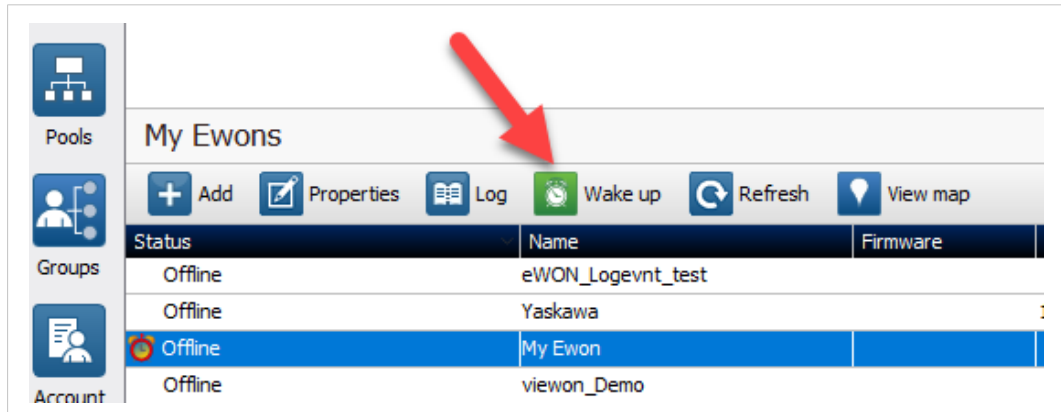

Fig. 9 Wake up your Ewon — 2

- Click the green **Connect** button (previously **Wake up** button) displayed in the Ewon list menu to establish the remote connection. eCatcher is now attempting to establish a VPN connection to the Talk2M server.

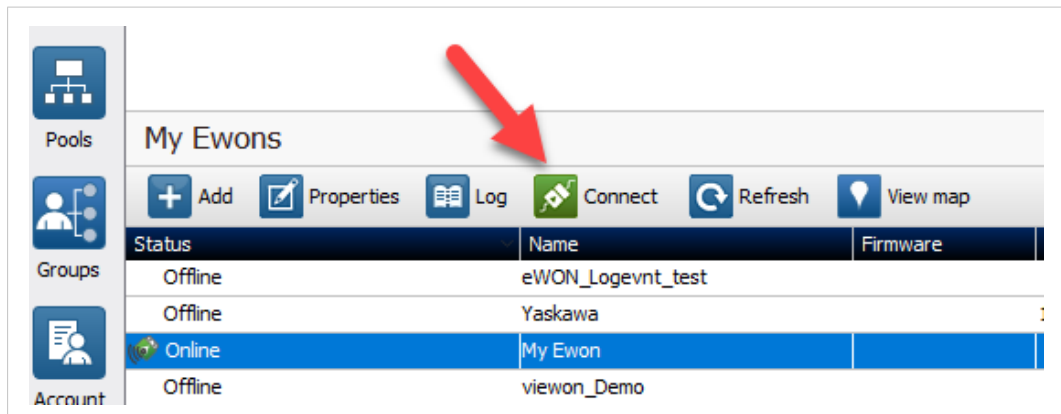

Fig. 10 Wake up your Ewon — 3

- Once the VPN connection established, eCatcher displays the Ewon in the "Active connection" section.



With your smartphone, you can also send the SMS "Talk2M_Connect" or "Talk2MConnect" to your Ewon to wake it up.

The computer is now connected to the Ewon using the VPN tunnel and you can use the remote connection.

You can click the **IP address** link in the "Active Connection" section to display, in a web browser, the homepage of the Ewon web interface.

5.5 Step 6: Terminate the Remote Connection



Before terminating the Talk2M VPN connection to the Ewon, it is mandatory to change the administrator password which is set by default to *adm*. Please refer to [Login security](#), p. 39.

To end the VPN connection and so the remote access to your Ewon, apply the following procedure:

1. Open eCatcher while you are remotely connected to your Ewon.
2. Click the red **Disconnect** button to terminate the remote access.
3. Optionally, leave a log message for future use.

You are now disconnected from your Ewon and can no longer use the remote access.



*By disconnecting, you terminate only the VPN tunnel. If you also want to send your Ewon offline (in case of a triggered Ewon), right-click on the Ewon in eCatcher and select **Go offline**.*

6 Link an Ewon to the PLC

The configuration of the Ewon can be slightly different if the connection between the PLC and the Ewon is serial- or Ethernet-based.

You can combine both connection types without any problem.

For example: at the same time, you can connect to an SLC500 using the Ewon serial port and connect to a (or multiple) ControlLogix PLC(s) using the Ewon Ethernet port(s).

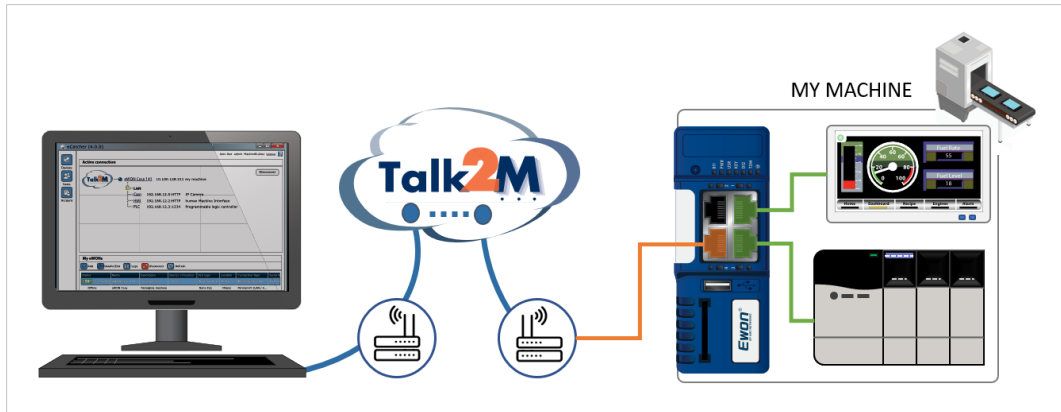

Fig. 11 Serial and Ethernet links between Ewon and Rockwell

6.1 Serial Port Configuration

The serial port between the Ewon and the Allen-Bradley is based on the DF1 protocol.

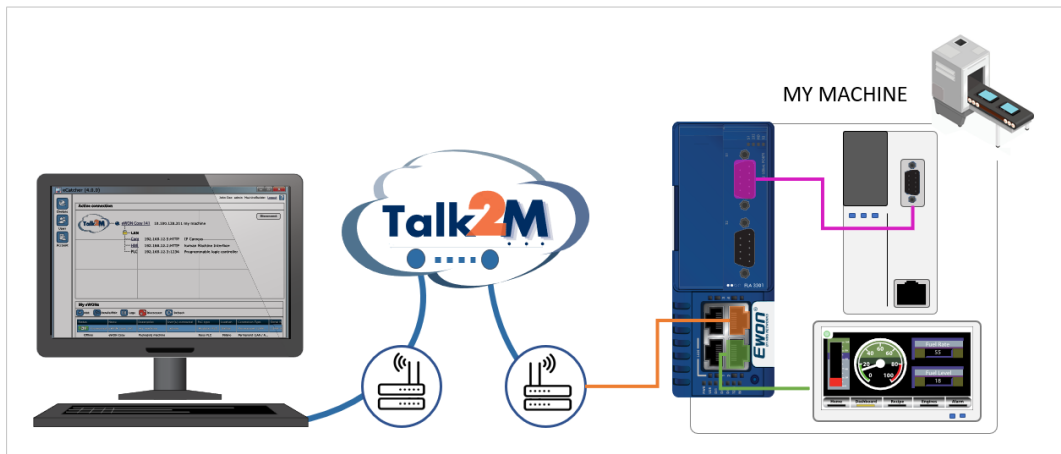
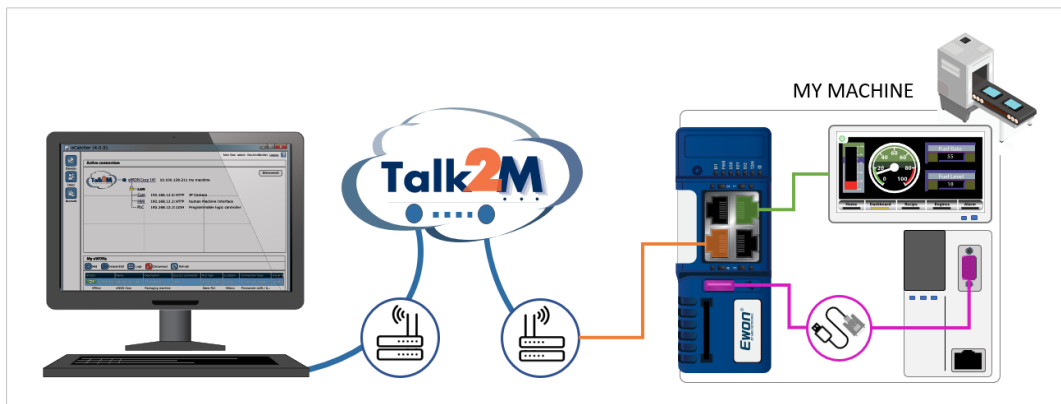

Fig. 12 DF1 protocol

To configure the serial port of the Ewon, follow the procedure:

1. Set the serial port of the Ewon to RS232 mode (all OFF):
 - On a Flexy 102 or 202: the built-in serial port is by default set to RS232. You can configure this serial port through the web interface of the Ewon.
 - On a FLA 3301 Flexy extension card: both serial ports are by default set to RS232. You can configure the serial port on top through the dip switch located behind the port.
2. Go to the web interface of your Ewon either using eCatcher (refer to [Step 6: Connect to Your Ewon Remotely, p. 34](#)) or by a local point-to-point connection to the LAN port of the Ewon.
3. Go to **Tags > IO servers**.
4. Select the IO server corresponding to your PLC type:
 - **DF1**: SLC500, Micrologix and PLC5 devices.
 - **ABLogix** : CompactLogix, ControlLogix and Flexlogix devices
5. Set the **Baudrate, Parity, Stop Bit** and **Frame Error detection** parameters as defined in your PLC:

On an SLC500 PLC, you can find this information in the *Channel configuration* window of your PLC project.

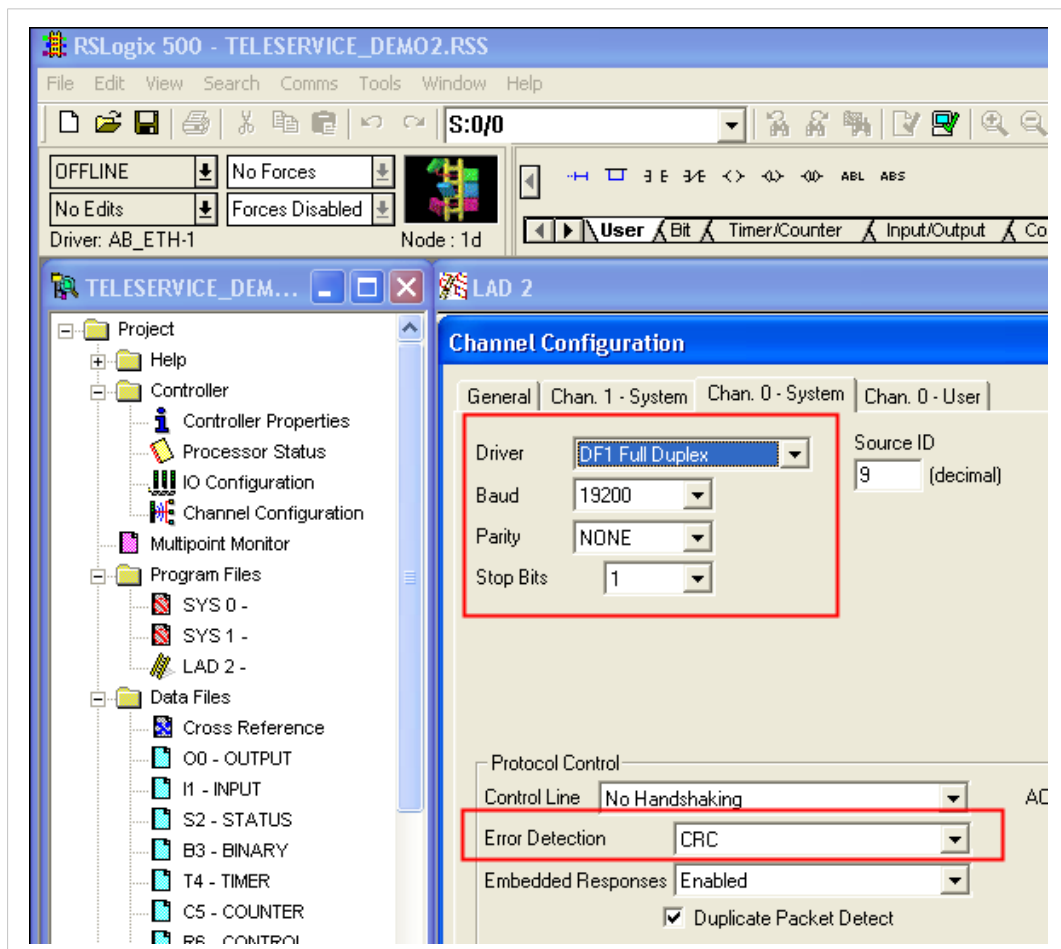

Fig. 13 SLC500 connection settings

6. Set the **HW Mode** to **Full Duplex NO Handshaking**.

7. Check **Bridge EIP connection** only if you connect to a CompactLogix, ControlLogix or Flexlogix PLC.

Do not check this option if you connect to an SLC500 or Micrologix.

8. Click the **Update** button to save your settings.
9. Connect the serial port of your Ewon to the serial port of the PLC.

Use a DF1 crossed cable as shown in [Types of Serial DF1 Cables, p. 41](#)). This is the same serial cable as when you connect the serial port of your PC to the serial port of the PLC.

In the PLC itself, the serial port must be set to **DF1 Full Duplex mode**. This is the standard setting when you use the PLC for program maintenance.

6.2 Ethernet Port Configuration

As of Ewon firmware 13.2s1, your Ewon embeds a feature called *PLC Discovery*.

The *PLC Discovery* allows the automatic detection of PLC(s) linked to an Ewon on the network while you are connected through Talk2M even if the PLC and the Ewon are not in the same IP range.

For more detail, please refer to the “PLC Discovery through Talk2M” from the [Related Documents, p. 3](#).

The *PLC Discovery* does not prevent you from configuring the Ewon and the PLC to be in the same IP range. The Ewon and the PLC in the same IP range is a requirement to make the remote access successful.

In most cases, it is no longer necessary to set the Ewon as gateway in the PLC. However, if you need to do so, please refer to [Ewon as the PLC Gateway, p. 36](#).

7 PLC Software Mapping

The mapping configuration of the PLC software must be done on a computer that:

- has the PLC software installed;
- is used to access remotely the Ewon.

Once configured, the PLC software knows it can use the remote connection instead of – or in addition to – the local connection.

You can configure the mapping with the following procedure:

1. Start the *RSLinx* application.
2. Go to *Communications > Configure Drivers* from the menu options.

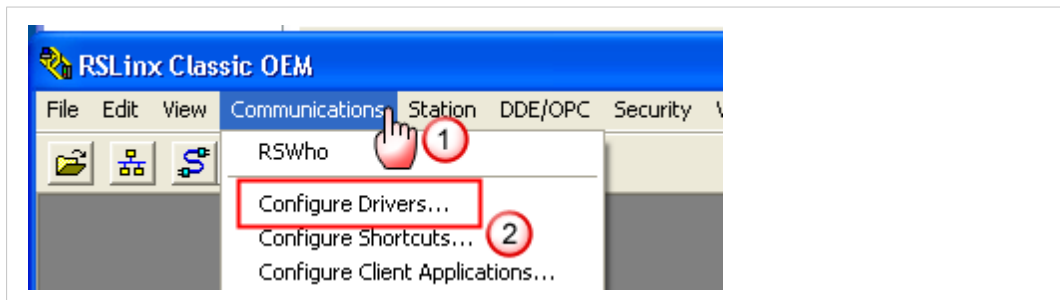

Fig. 14 Drivers configuration in RSLinx

3. Select (or add) the *AB_ETH-1 (Ethernet Devices)* driver.
4. Click the *Configure* button.
5. Click the *Add New* button.

- Add the IP address that represents the PLC in the *Station Mapping* table.

This IP address depends on the type of connection between the PLC and the Ewon:

- Serial link: enter the LAN IP address of the Ewon (e.g.: in our case, it would be 192.168.0.53).
- Ethernet link: enter the IP address of the PLC (e.g.: in our case, respectively 192.168.0.61 for the Logix series and 192.168.0.62 for the SLC500 series).

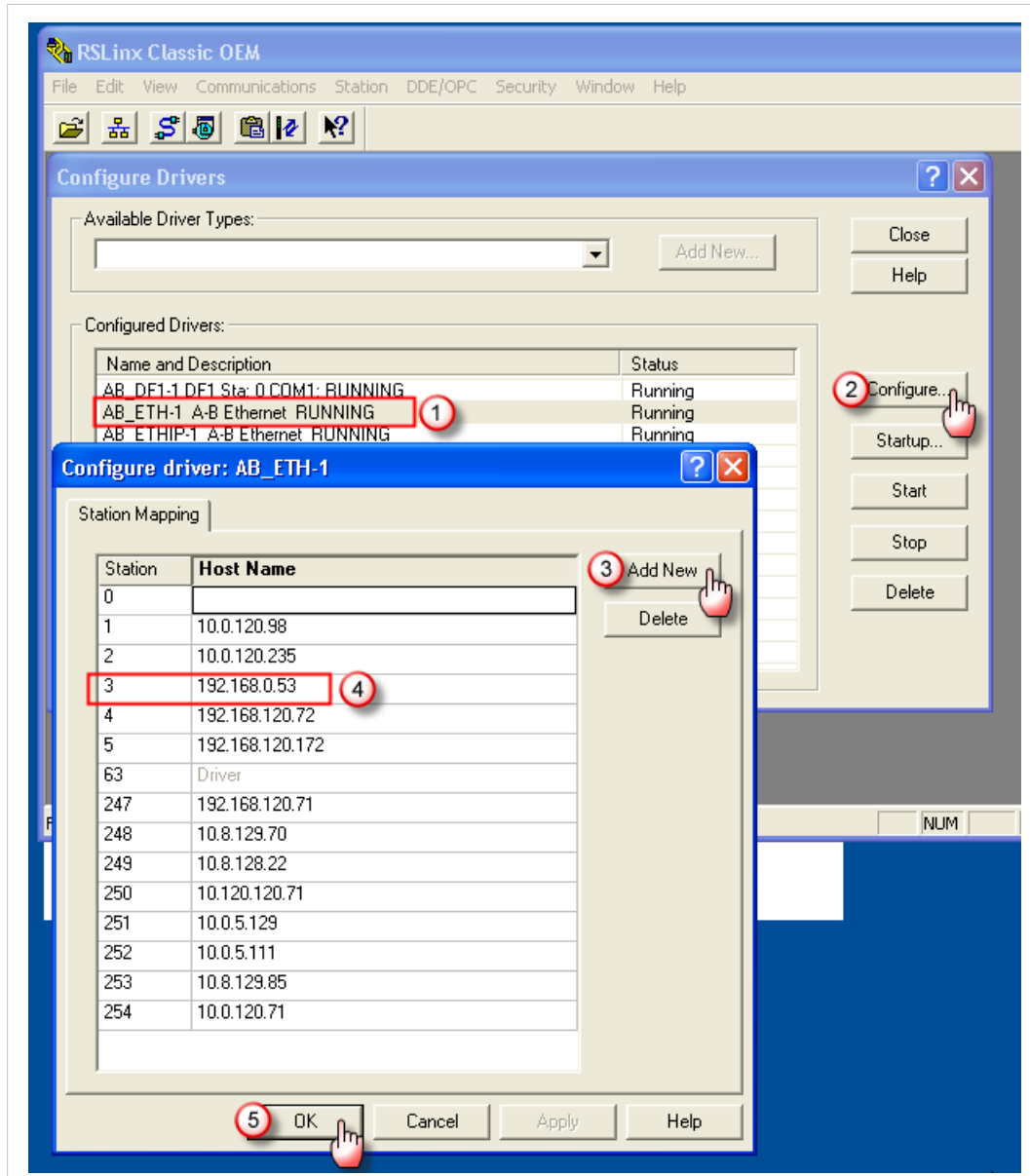

Fig. 15 Ethernet driver

- Click **OK** or **Close** to quit the *Configure driver* window.

8. Go to **Communications > RSWho** from the RSLinx® menu to check whether your new PLC appears in the list of connected devices.

Allow enough time for the *Autobrowser* function to find your new device.

You might need to expand manually the driver family that holds your new PLC (e.g.: in our case, it is the *AB_ETH-1, Ethernet*).

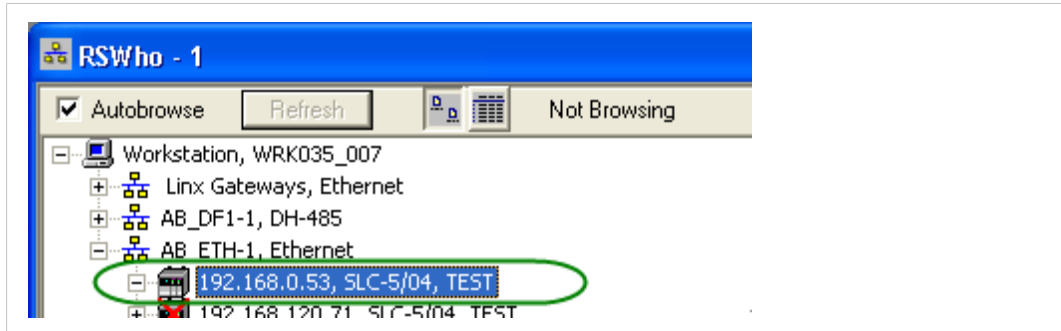

Fig. 16 Check on the PLC status

8 PLC Remote Access

To perform the remote access through the PLC software, follow this procedure:

1. Establish the remote connection to your Ewon based on the explanation of [Step 6: Connect to Your Ewon Remotely, p. 34](#).
2. Start RSLogix® once you are connected to your Ewon through Talk2M.
3. Select one of these options in RSLogix®:
 - **Who Active Go Online** for RSLogix500®.
 - **Who Active** for RSLogix5000®.

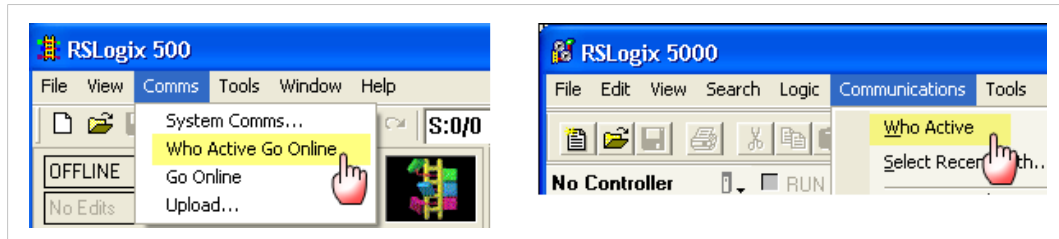

Fig. 17 Go online in RSLogix®

4. Select one these options from the three menu:
 - IP address of the Ewon for serial connection.
 - IP address of the PLC itself for Ethernet connection.

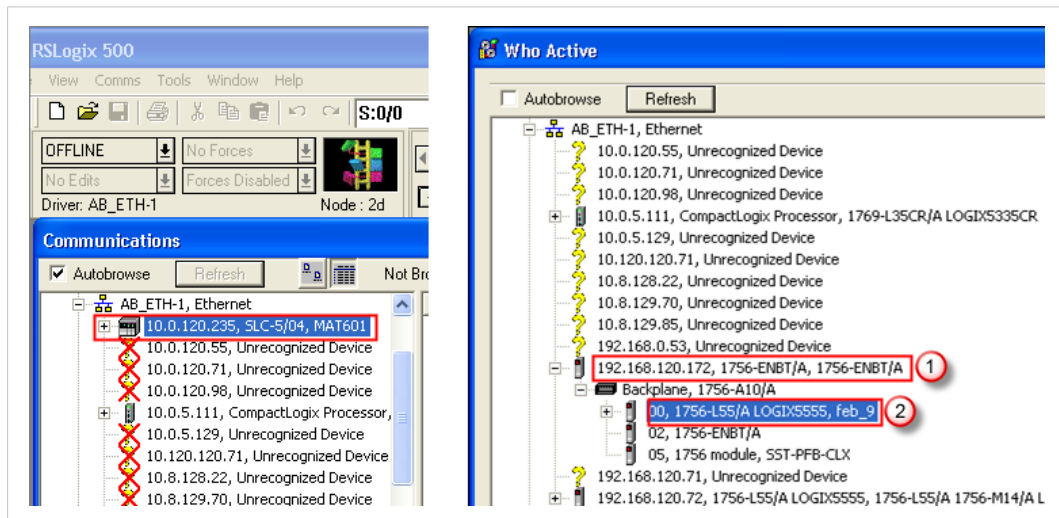

Fig. 18 IP address of the PLC

5. Click on
 - **OK** for RSLogix500®.
 - **GO Online** for RSLogix5000®.
6. Wait until the connection occurs.

This can last especially when using a modem connection since the throughput might be relatively slow.

7. You can check the status of the connection in the status bar of RSLogix®.

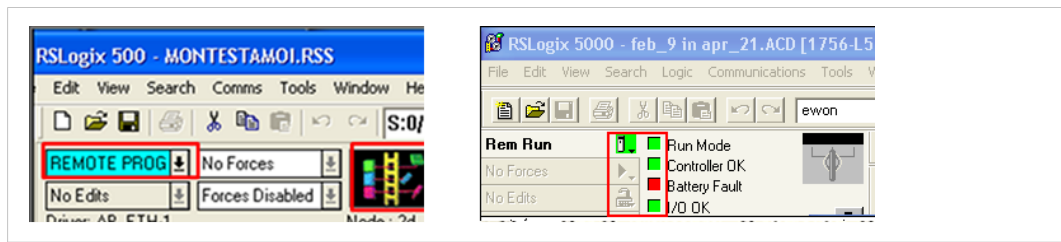

Fig. 19 Connection status

As soon as the connection is established, you can work in remote programming mode.

Once you finished the remote programming with RSLogix®, go offline in the RSLogix® software and terminate the remote connection to your Ewon as explained in [Step 7: Terminate the Remote Connection, p. 35](#).

9 Troubleshooting

9.1 Cannot Reach Serial PLC?

If you cannot reach the serial PLC connected to the Ewon then verify the following items:

- Check the serial dip switch positions of the Ewon which should be all *OFF* for RS232). See [Serial Port Configuration, p. 15](#).
- Check the IO server configuration in your Ewon which concerns the *DF1* and associated protocol settings. See [Serial Port Configuration, p. 15](#).
- Open the Ewon *Event Log* located at **Main Menu > Diagnostic > Event Log** to check for error messages.
- Check if the Ewon has the correct IP address in RSLink®. Use either the Ewon LAN IP address or the Ewon VPN IP address.

9.2 Cannot Reach Ethernet PLC ?

If you cannot reach your PLC through Ethernet, it might be because of the following reasons:

- You did not reboot the PLC after you modified the IP address and/or the gateway.
- There is a possible mismatch between your Ewon's current IP address and the LAN IP address of your Ewon recorded in the Talk2M account.

Check these settings in eCatcher and, if necessary, modify them. To do so, select your Ewon in eCatcher and hit the **Properties** button, then click on the **Modify LAN subnet** button.

Disconnect and reconnect to your Ewon in eCatcher to apply the modification.

To verify if the Ewon port and the Ewon IO server are correctly configured, you can create a tag inside the Ewon which polls a register from the PLC. If the polling succeeds, the PLC connection works correctly.

9.3 Check the Configuration of an Ewon Flexy

To verify the configuration of the Ewon port and the Ewon IO server, you can create a tag inside the Ewon Flexy which polls a register from the PLC. If the polling succeeds, the PLC connection is working correctly.

This page intentionally left blank

A Configure your Ewon for Remote Access using the Web Interface

This section explains how to configure the remote access of your Ewon through Talk2M with the help of eBuddy and Ewon web interface.

Before going through the configuration of your Ewon to set the remote access, we recommend reading the [Prepare your Ewon for Remote Access, p. 6](#).

A.1 Step 1: Set the LAN IP Address of your Ewon

Once you have selected your IP addresses, you can start configuring your Ewon.

In our example, the Ewon is set to LAN IP address 192.168.0.53. This address fits into the PLC range and does not interfere with the *Company LAN*.

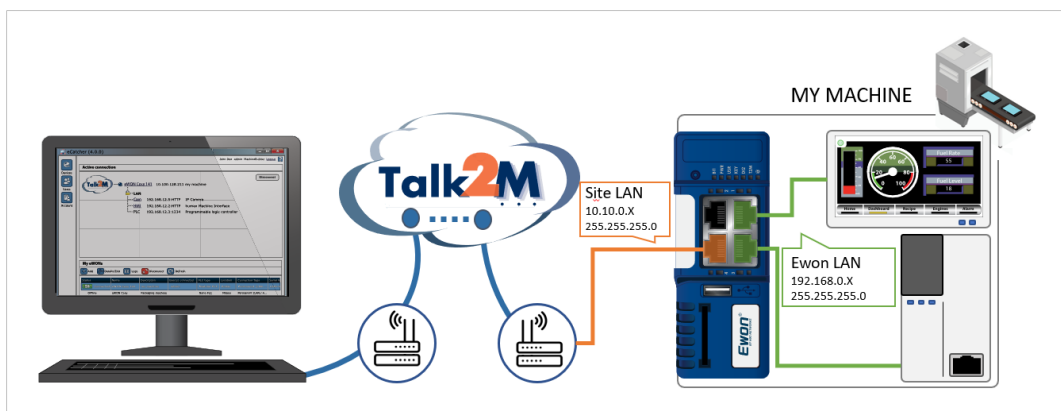

Fig. 20 Example of IP addresses involved

In this step, there is no constraint on the IP range of your computer.

To configure the LAN IP address of your Ewon:

1. Link your computer to the LAN port of your Ewon.

Usually, this link is made through the company network but It can also be made with a point-to-point link.



Fig. 21 Connect the computer indirectly to the Ewon though Company LAN

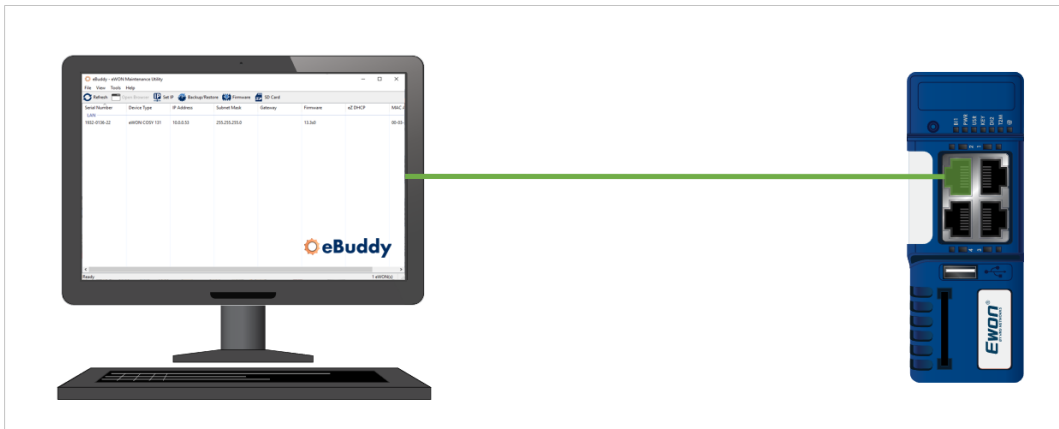

Fig. 22 Connect the computer directly to the Ewon

2. Open eBuddy.

eBuddy can display your Ewon in its list even if your computer has a different network address range than your Ewon.

3. Highlight (click on) your Ewon in the eBuddy list.

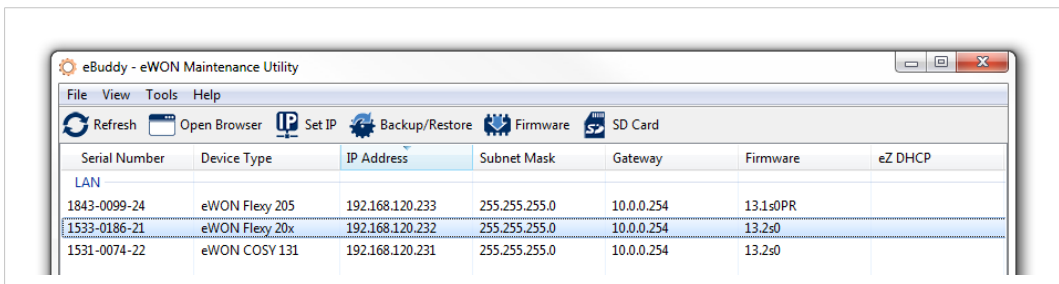

Fig. 23 eBuddy — Selection of the Ewon

- Click the **Set IP** button.

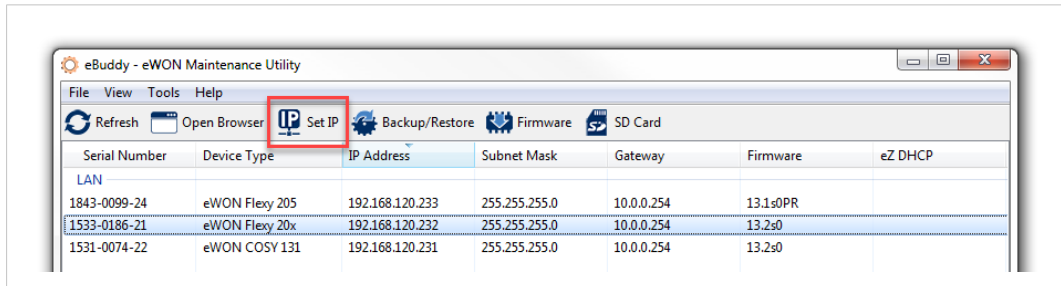

Fig. 24 eBuddy — Set IP button

- Set the **Serial Number** of your Ewon if the field is empty.

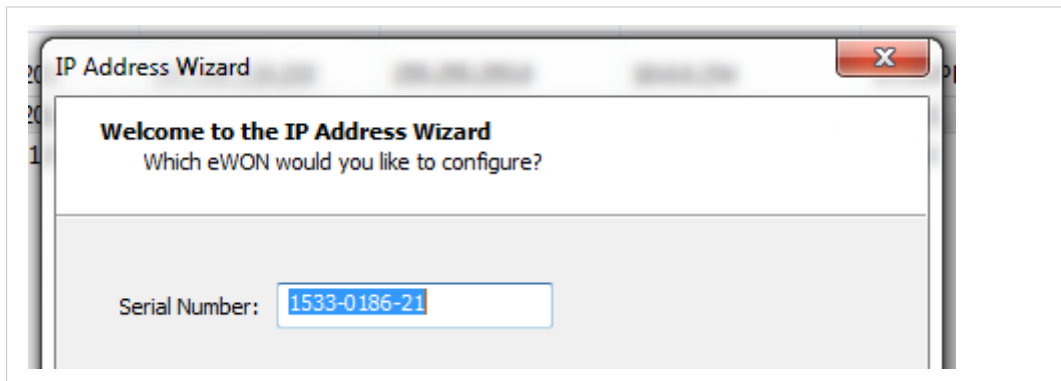

Fig. 25 eBuddy — Serial number field

If you don't know your Ewon's serial number, you can look it up on the right side of the Ewon itself.

- Click **Next**.
- Set the new LAN IP address and Subnet Mask of your Ewon, based on [Prepare your Ewon for Remote Access, p. 6](#).

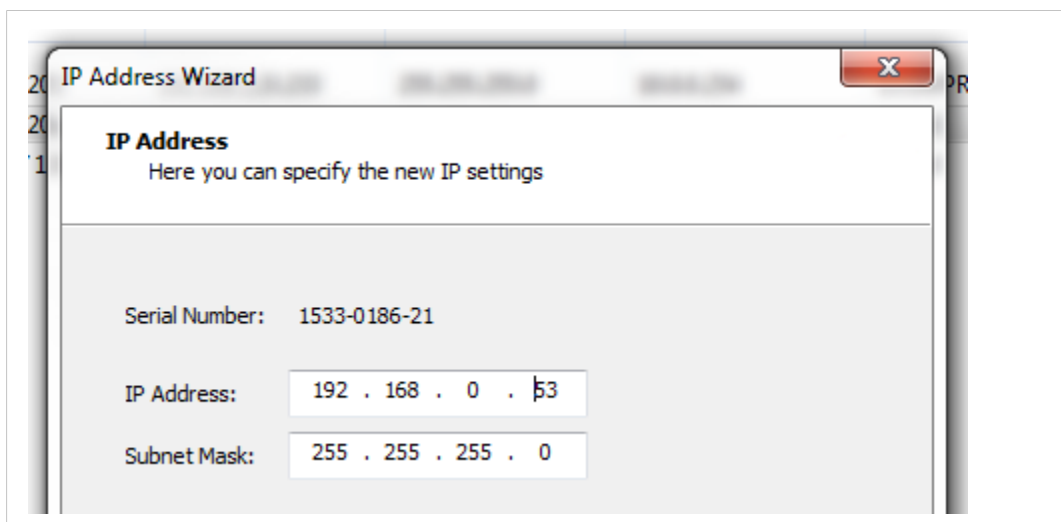

Fig. 26 eBuddy — LAN IP address and Subnet mask

- Click **Next**.

9. Wait until the Ewon reboots.

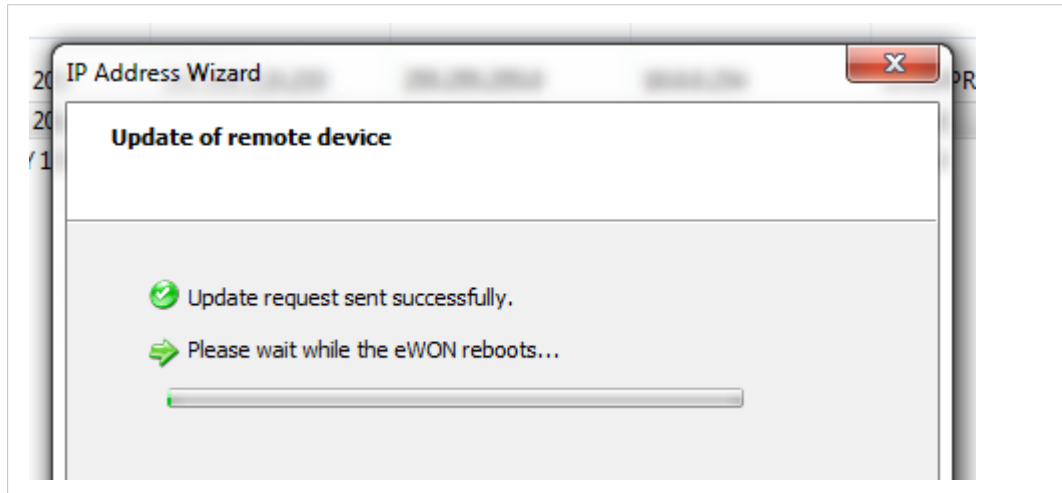

Fig. 27 eBuddy — Reboot of the Ewon

10. Click **Finish**.

A.2 Step 2: Configure the Ewon Internet Connection

To configure the Internet connection of your Ewon, follow these steps:

1. Link your computer to the LAN port of your Ewon.
Usually, this link is made through the company network but It can also be made with a point-to-point link.
2. Open **eBuddy** (if not already open).
3. Highlight the **Ewon** you want to connect to.
4. Right-click on this Ewon.
5. Select **Open in browser**.
6. Log in to your Ewon.
7. Click the **Wizard** button in the top right corner.
8. [Recommended] Go through the System wizard before setting the Internet connection.
The system wizard lets you change the password of the administrator but also sets the date & time of the Ewon.
Click the **System** button in the right-side menu and follow the different steps.
9. Click the **Internet** button in the right-side menu.
10. Select the WAN interface of your Ewon. The propositions displayed are based on the model of your Ewon



WAN refers to Wide Area Network which is the network covering a broad external area using the Internet infrastructure. It is opposed to LAN referring to Local Area Network which is restricted to internal networks.

To continue the Internet step-by-step guide, select your interfaces:

- [Ethernet Connection, p. 29](#);
- [Wi-Fi Connection, p. 29](#);
- [Cellular Connection, p. 30](#).

A.2.1 Ethernet Connection

1. Make sure the WAN port of the Ewon is physically connected to the company network.
The LED dedicated to WAN traffic activity doesn't blink yet as the WAN connection is not yet defined.
2. Click **Next**.
3. Select the network management protocol:
 - static;
 - BootP;
 - DHCP.

We recommend using **DHCP**. This way, your Ewon receives an IP address and Internet access automatically from host.

4. Click **Next**.
5. **Enable** the Internet connection test.
6. Click **Next**.

The last step of the Internet configuration consist in a communication test.

The *Online IP Check* performed during the connectivity test aims at validating the WAN IP address by reaching a specific domain on Internet on a specific port.

If your network parameters are correct, this test should end up successfully.

If the Internet connection test is not successful, then go back through the previous configuration steps and recheck all settings for compatibility and accuracy.



*Your network firewall should allow connections to *.talk2m.com on port 80. Otherwise, the Online IP Check fails.*

More information about the configuration of your Ewon for Internet access using the wizard can be found in the [Related Documents, p. 3](#).

A.2.2 Wi-Fi Connection

1. Click **Next**.
2. Enter the name of the Wi-Fi network (SSID) and its password.
3. Select the network management protocol:
 - static;
 - BootP;
 - DHCP.

We recommend using **DHCP**. This way, your Ewon receives an IP address and Internet access automatically from host.

4. Click **Next**.
5. **Enable** the Internet connection test.
6. Click **Next**.

The last step of the Internet configuration consist in a communication test.

The *Online IP Check* performed during the connectivity test aims at validating the WAN IP address by reaching a specific domain on Internet on a specific port.

If your network parameters are correct, this test should end up successfully.

If the Internet connection test is not successful, then go back through the previous configuration steps and recheck all settings for compatibility and accuracy.



*Your network firewall should allow connections to *.talk2m.com on port 80. Otherwise, the Online IP Check fails.*

More information about the configuration of your Ewon for Internet access using the wizard can be found in the [Related Documents, p. 3](#).

A.2.3 Cellular Connection

1. Click **Next**.
2. Enter the information related to the SIM card and the APN.
3. Click **Next**.
4. Select the connection type:
 - Maintain connection: your Ewon is permanently connected.
 - Triggered: you must wake up your Ewon by sending an SMS so it initializes the connection.
5. Click **Next**.
6. Set the call budget if the connection type is set **triggered**:
 - Idle time: the amount of time before the Ewon shuts down the connection if there is no traffic from/to the Ewon.
 - Call duration: the amount of time the Ewon stays online before closing the outgoing connection.
7. Click **Next**.

The *Online IP Check* performed during the connectivity test aims at validating the WAN IP address by reaching a specific domain on Internet on a specific port.

If your network parameters are correct, this test should end up successfully.

If the Internet connection test is not successful, then go back through the previous configuration steps and recheck all settings for compatibility and accuracy.



*Your network firewall should allow connections to *.talk2m.com on port 80. Otherwise, the Online IP Check fails.*

More information about the configuration of your Ewon for Internet access using the wizard can be found in the [Related Documents, p. 3](#).

A.2.4 WAN Fallback

If another WAN interface is available, a popup appears at the end of the Internet wizard and offers to configure this secondary WAN interface.

If configured, the Ewon switches automatically to this secondary WAN interface in case the primary interface fails.

The configuration of the secondary WAN interface is a replay of the Internet wizard where the proposed settings are based on this second WAN interface type.

More info on the WAN Fallback in the “WAN Connection Fallback” from [Related Documents, p. 3](#).

A.3 Step 3: Create Your Ewon in Talk2M

This step consists in listing your Ewon inside your Talk2M account using the [eCatcher](#) software.



If you already created your Ewon in your Talk2M account, through eCatcher, you can skip this step and go to the next step.

To create your Ewon in Talk2M, apply the following procedure:

1. Connect your computer to the company LAN.
2. Set the network parameters of your computer to **DHCP enabled**. An IP address is automatically provided from the DHCP server of the company network.
3. Verify that you have an Internet connection. For example: open your web browser and browse to your favorite web page.
4. Open eCatcher if your Internet connection works.
5. On eCatcher's main interface, click the **+ Add** icon. A new window appears.
6. Enter the name of your Ewon. The Talk2M server displays this name to identify the remote connection to your Ewon
7. Select the **Connection Type** to specify how your Ewon connects to the Talk2M server. You can choose between two possibilities:
 - Permanent: for Ethernet, Wi-Fi or cellular models. Your Ewon stays permanently online.
 - Triggered: only for cellular models. Your Ewon is offline (but still functional) until you wake it up with an SMS.

If you specify a triggered connection, then eCatcher asks for the phone number of your Ewon. The phone number allows Talk2M to send a n SMS which wakes up your Ewon.
8. Click **Next**.
9. Enter custom information concerning your remote connection. You can use the **Custom Fields** to classify or filter your different remote connections (your different Ewons).
10. Click **Create**.

The newly created Ewon is now linked to your Talk2M account.

eCatcher displays the "Talk2M Connectivity" frame. Follow the [Step 4: Retrieve the Talk2M Activation Key, p. 31](#) to continue the configuration of the remote access.

A.4 Step 4: Retrieve the Talk2M Activation Key

Up to now, we only added the Ewon in your Talk2M account but we didn't configure the Ewon to connect to the Talk2M server.

One way to enable the link between your Ewon and the Talk2M server is with the activation key. The activation key allows the Ewon to retrieve the VPN keys and certificates useful to establish the VPN connection.

Continue the [Step 3: Create Your Ewon in Talk2M, p. 31](#) and, in the "Talk2M Connectivity" frame, get the activation key by proceeding as follows:

1. Click the **Copy to Clipboard** button from the **Activation Key** row.

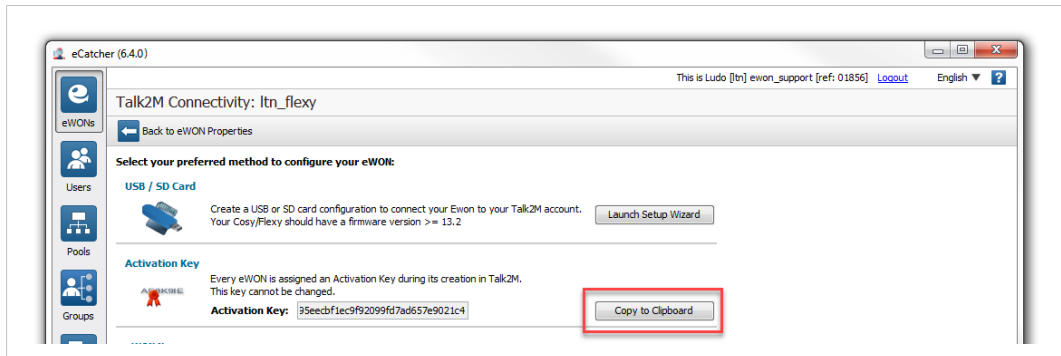

Fig. 28 eCatcher — Activation key

If you are not in the “Talk2M Connectivity” frame but in eCatcher’s main window instead, follow this process to retrieve the activation key:

1. Select your Ewon in the “My Ewons” list.
2. Click the **Properties** button.

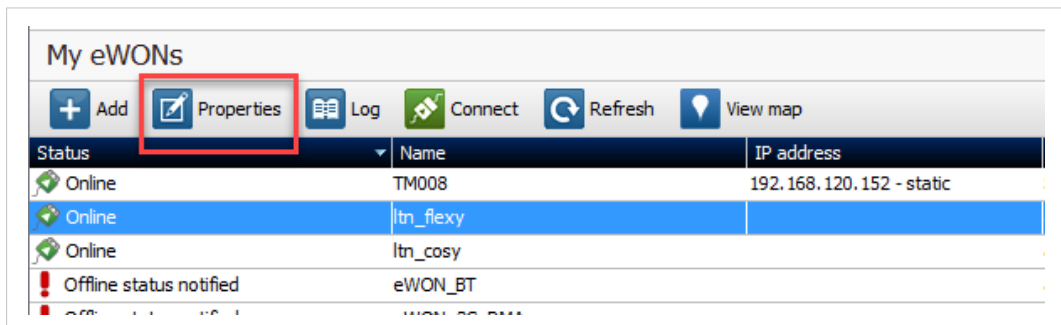

Fig. 29 eCatcher — Properties of an Ewon

3. Click the **Talk2M Connectivity** button.

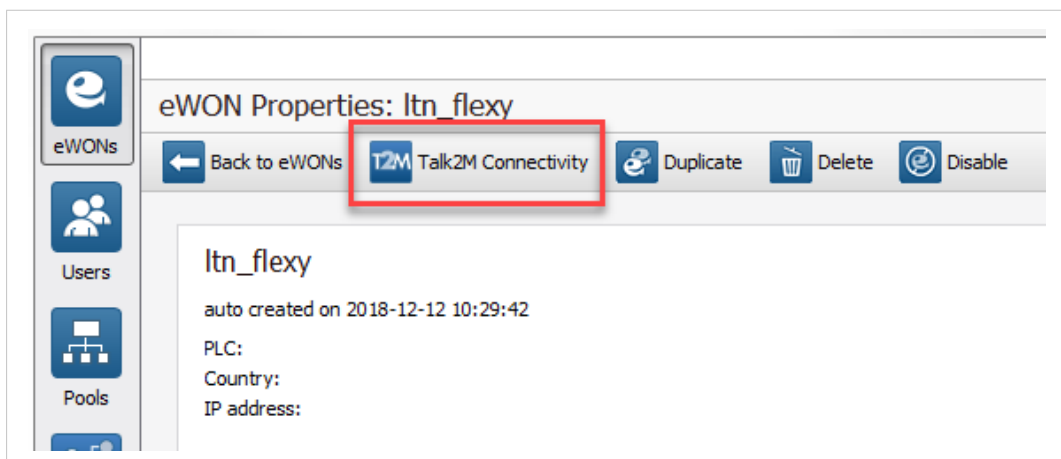

Fig. 30 eCatcher — Talk2M Connectivity

4. Click the **Copy to Clipboard** button from the **Activation Key** row.

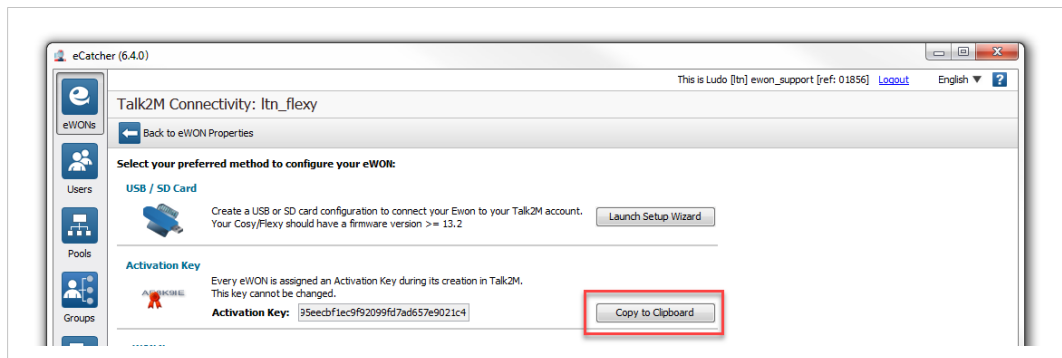

Fig. 31 eCatcher — Activation key

A.5 Step 5: Connect Your Ewon to Talk2M

To configure the Ewon Talk2M connection, follow the steps below:

1. Configure the network parameters of your computer to fit into the IP range of your Ewon LAN.
If you need help to do this, please refer to [Google](#)[®].
2. Connect your computer to a LAN port of your Ewon.
3. Open your web browser and target the Ewon internal web page by browsing the LAN address you configured in [Step 1: Set the LAN IP Address of your Ewon, p. 25](#).
In our example, that would be: <http://192.168.0.53>.
4. Click the **Wizard** button in the top right corner.
5. Click the **Talk2M – VPN** button.
6. Click the **T2M** button.
7. Insert the activation key copied from [Step 4: Retrieve the Talk2M Activation Key, p. 31](#).
8. Click **Next**.
9. Set the advanced configuration if needed. The advanced settings concern:
 - the use of a proxy for the WAN connection,
 - the obligation to use TCP packets instead of UDP for the WAN connection.
10. Click **Next**.

The last step of this wizard is the Talk2M registration and so the establishment of the VPN tunnel between your Ewon and Talk2M. The following tests are performed:

- the Ewon tests the different connections needed to reach the Talk2M server (UDP/TCP, HTTP with/without proxy),
- the Ewon connects to the Talk2M server and retrieves the VPN keys,
- once the keys retrieves, the VPN tunnel is established.

The result is displayed on the wizard page. Click **Finish** to end the wizard.

Your Ewon now appears online in eCatcher.

A.6 Step 6: Connect to Your Ewon Remotely

Now that the Ewon is configured to connect to Talk2M, you can establish the remote connection to this Ewon.

Depending on the type of connection you set, the procedure changes.

A.6.1 Permanent Connection

To connect remotely to an Ewon tagged as permanent connection, follow the procedure:

1. Connect your computer to the company LAN.
2. Set the network parameters of your computer to "DHCP enabled". An IP address is automatically provided from the DHCP server of the company network.
3. Verify that you have an Internet connection. For example: open your web browser and browse to your favorite web page.
4. Open eCatcher (if not already opened).
5. Select the Ewon you just configured in the "My Ewons" list.
6. Click the green **Connect** button displayed in the Ewon list menu to establish the remote connection. eCatcher is now attempting to establish a VPN connection to the Talk2M server.
7. Once the VPN connection established, eCatcher displays the Ewon in the "Active connection" section.

The computer is now connected to the Ewon using the VPN tunnel and you can use the remote connection.

You can click the **IP address** link in the "Active Connection" section to display, in a web browser, the homepage of the Ewon web interface.

A.6.2 Triggered Connection

To connect remotely to an Ewon tagged as triggered connection, follow the procedure:

1. Connect your computer to the company LAN.
2. Set the network parameters of your computer to "DHCP enabled". An IP address is automatically provided from the DHCP server of the company network.
3. Verify that you have an Internet connection. For example: open your web browser and browse to your favorite web page.
4. Open eCatcher (if not already opened).
5. Select the Ewon you just configured in the "My Ewons" list.
6. Click the green **Wake up** button displayed in the Ewon list menu to wake up your Ewon.
By doing so, eCatcher sends an SMS to switch your Ewon online.
7. Click the green **Connect** button (previously **Wake up** button) displayed in the Ewon list menu to establish the remote connection. eCatcher is now attempting to establish a VPN connection to the Talk2M server.
8. Once the VPN connection established, eCatcher displays the Ewon in the "Active connection" section.

The computer is now connected to the Ewon using the VPN tunnel and you can use the remote connection.

You can click the **IP address** link in the "Active Connection" section to display, in a web browser, the homepage of the Ewon web interface.

A.7 Step 7: Terminate the Remote Connection



Before terminating the Talk2M VPN connection to the Ewon, it is mandatory to change the administrator password which is set by default to *adm*. Please refer to [Login security, p. 39](#).

To end the VPN connection and so the remote access to your Ewon, apply the following procedure:

1. Open eCatcher while you are remotely connected to your Ewon.
2. Click the red **Disconnect** button to terminate the remote access.
3. Optionally, leave a log message for future use.

You are now disconnected from your Ewon and can no longer use the remote access.



*By disconnecting, you terminate only the VPN tunnel. If you also want to send your Ewon offline (in case of a triggered Ewon), right-click on the Ewon in eCatcher and select **Go offline**.*

B Ewon as the PLC Gateway

If the *Plug'n'Route* function does not work or apply in your configuration, then you need to disable the *Plug'n'Route* feature in the Ewon and configure manually the Ewon LAN IP address as default gateway in the configuration of the PLC.

To disable the *Plug'n'Route* function, open the Ewon web interface and follow these steps:

- Click on **System**.
- Click on **Communication**.
- Click on **Routing**.
- Select **NAT and TF disabled** from the *Apply NAT and TF to connection* field.
- Click the **Update** button.
- Reboot the Ewon.

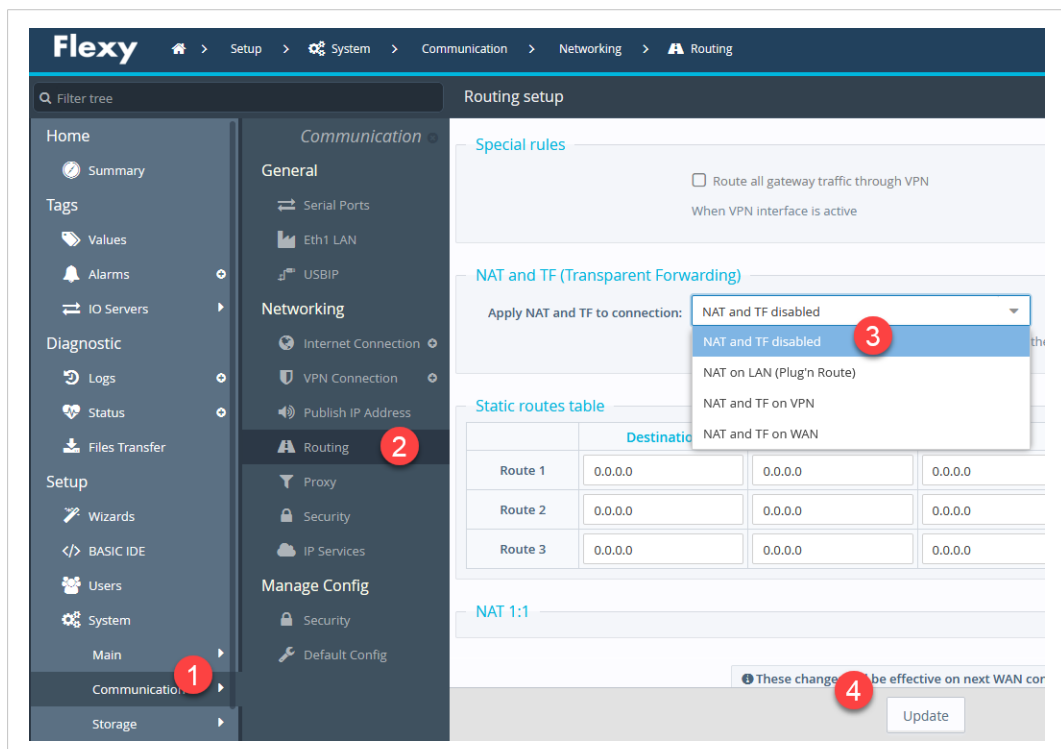

Fig. 32 Routing path in Ewon

B.1 SLC500 Series

If you work with a PLC of the SLC500 series, follow these steps:

- Connect a PC to the Ethernet port of the PLC. The computer must have a fixed IP that is in the the same PLC IP range.
- Select **Comms** from the RSLogix 500®.
- Go **Online**.
- Open the **Channel Configuration** window.
- Check (or set) the IP address of the PLC which has to be in same range as the Ewon LAN.
- Enter the Ewon LAN address as gateway.

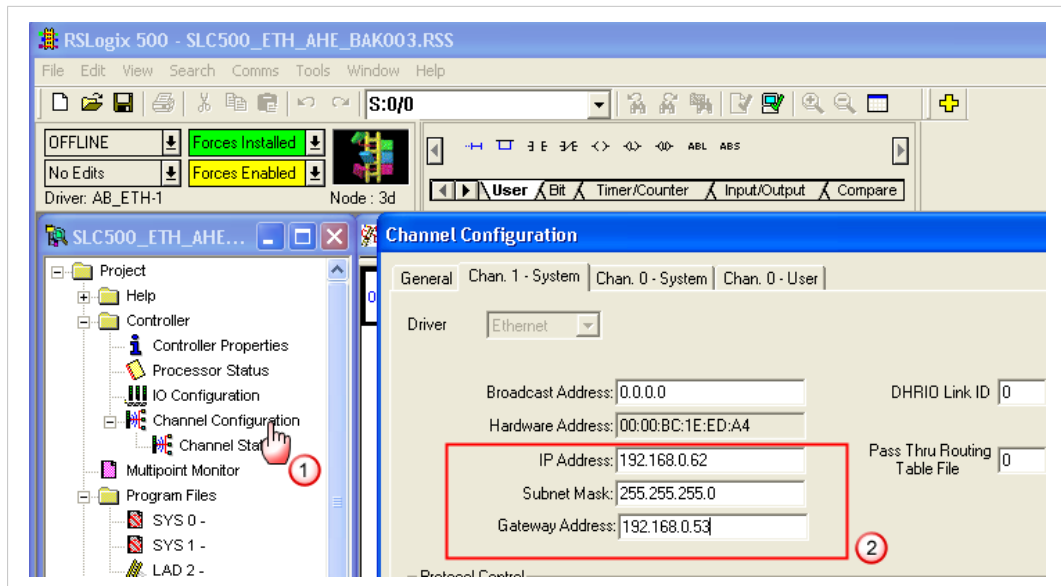

Fig. 33 IP addresses verification in RSLogix500®

B.2 Logix Series

If you work with a PLC of the Logix series, follow these steps:

- Start RSLogix 5000®.
- Select **Communications**.
- Select **Who Active**.
- Go **Online**.
- Open the properties panel of the Ethernet card.
- Set the IP address of the PLC which has to be in same range as the Ewon LAN.
- Enter the Ewon LAN address as gateway.
- Click on **Set**.
- Click on **Apply**

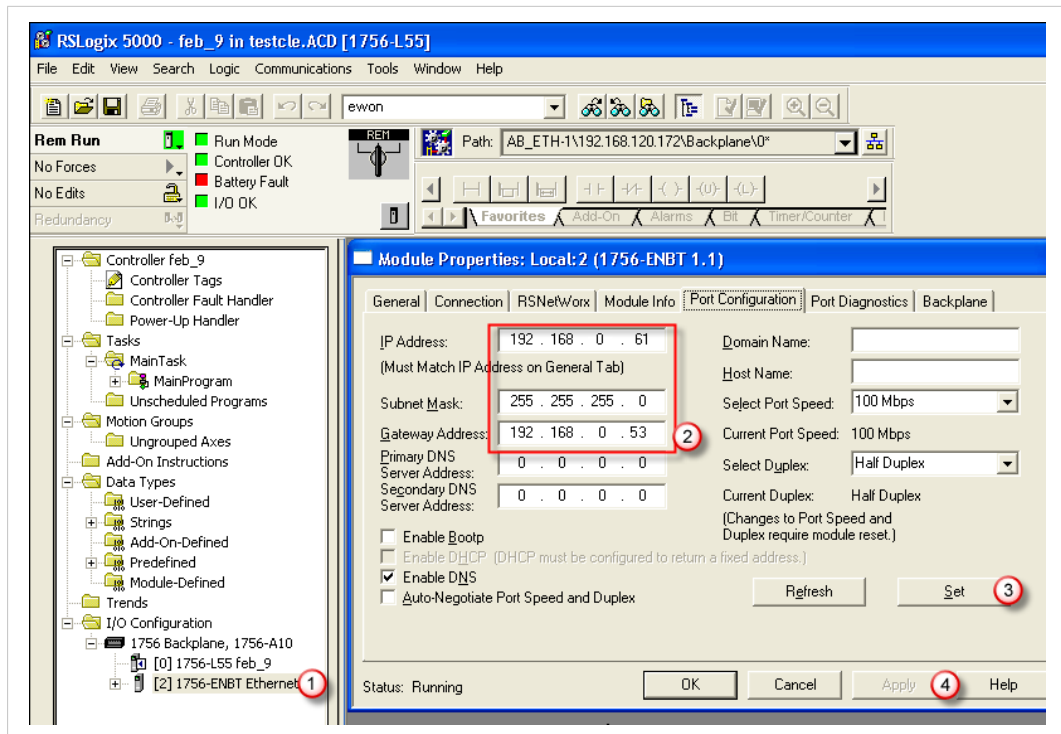

Fig. 34 IP addresses verification in RSLogix5000

Do not forget to save the new settings into the PLC. If you want to make sure they are saved, go offline and back online, and check whether the uploaded configuration is OK.

Once done, you can make the physical link between the PLC to the Ethernet LAN port of the Ewon.

C Security Aspects

C.1 Login security

It is required to modify the login and password of the default administrator which are both *adm*.

 *The default adm administrator can be modified but not deleted.*

C.1.1 For Ewon Cosy

To modify the default administrator, follow these steps:

- Log in to the Ewon web interface.
- Click on **Wizards** in the upper right corner.
- Click on **System**.

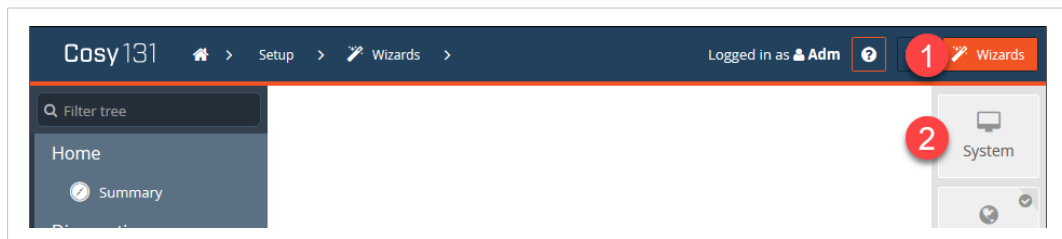

Fig. 35 Change administrator password — 1

- Set the new password for the Adm user.

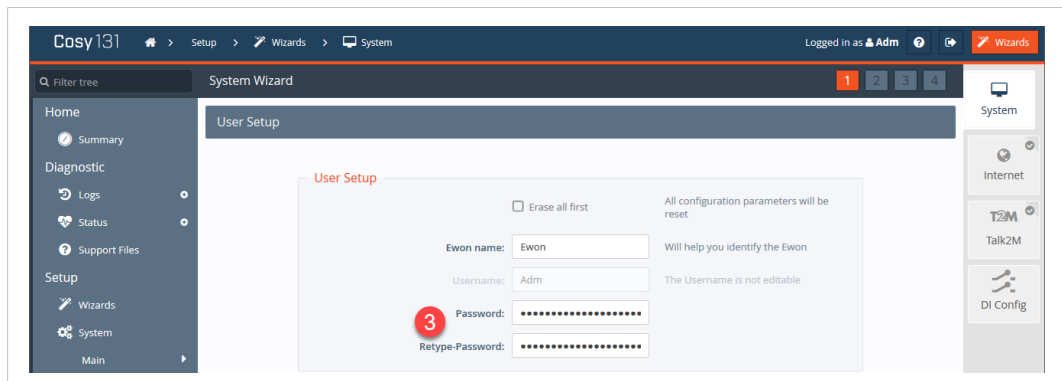

Fig. 36 Change administrator password — 2

- Click on **Next**.
- Follow and end the rest of the wizard to apply the new configuration.

C.1.2 For Ewon Flexy

To modify the default administrator, follow these steps:

- Log in to the Ewon web interface.
- Click on **Setup**.
- Click on **Users**.
- Click on **Adm** user.
- Click on **Configure**.

- Set the new password.
- Click on **Update User**.

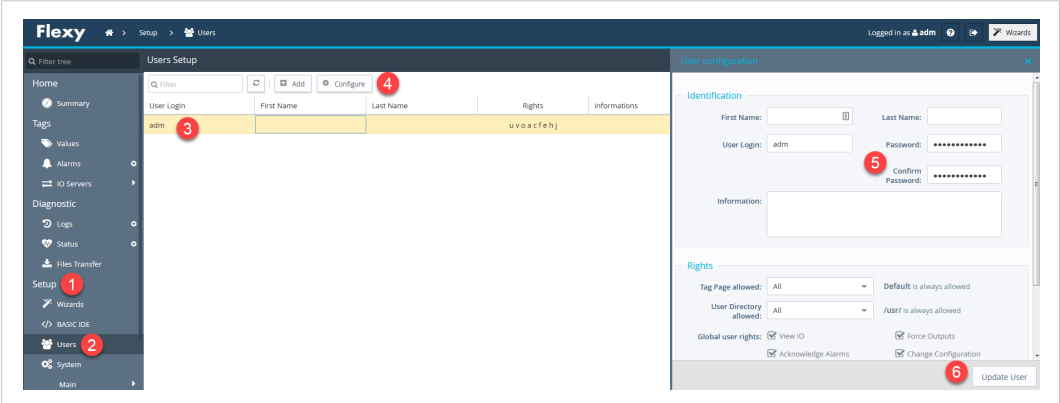

Fig. 37 Modification of administrator password

D Types of Serial DF1 Cables

D.1 Serial Cable 1747-CP3

You can use the standard Allen-Bradley serial cable. One of the basic genuine Allen-Bradley references is 1747-CP3.

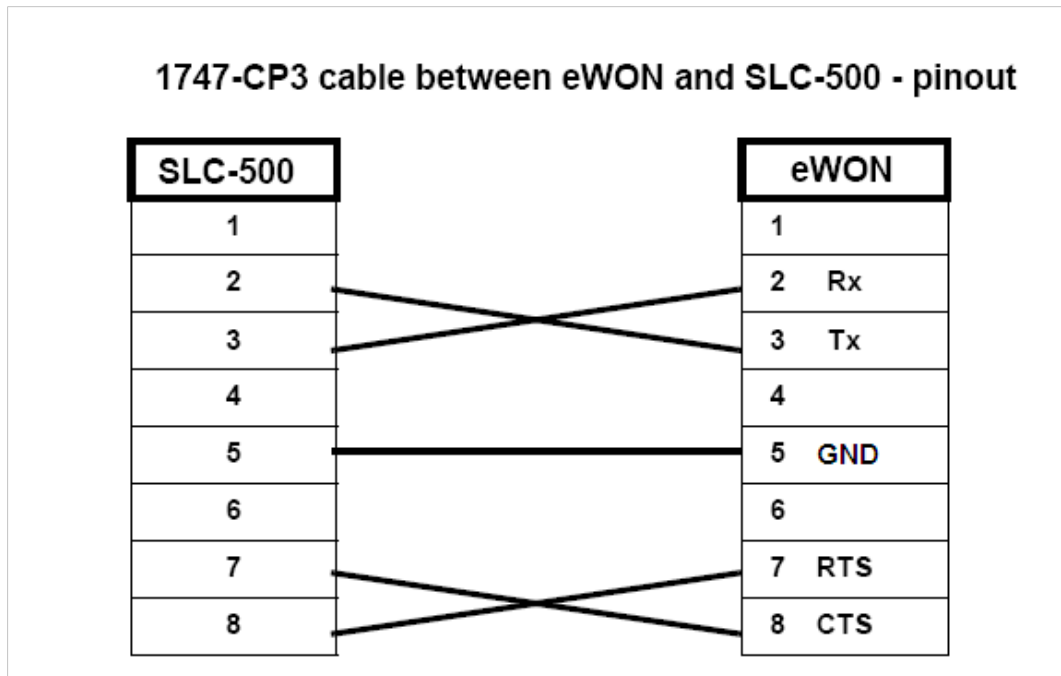

Fig. 38 Serial cable 1747-CP3

